



SCHIEDEL INSTALLER
REWARDS

SCHIEDEL

Prima Plus

Installation Instructions

DON'T FORGET TO REGISTER YOUR INSTALLATIONS
AND START EARNING SCHIEDEL INSTALLER REWARDS
See inside for more details

www.schiedel.com/uk

SAP Issue 2 | 940003422 | April 2019

Contents

Page 2	Approvals	Page 19-20	Typical installations
Page 3	Design guide	Page 21	Max offset info
	- Mandatory requirements	Page 21	Component weightsAfter installation
Page 4	Prior to installation		- Testing and commissioning prior
	- Ventilation		
	- Carbon monoxide alarms		
	- Handling		- Appliance operation
	- Delivery to site and storage		- Multi-fuel applications
Page 5-6	Connecting flue pipe	Page 23	- Maintenance
	- Appliance/chimney connection		- Fuel storage and usage
	- Connecting flue pipe diameter		Product guarantee
	- Distance to combustibles		- Product registration
	- Connecting flue pipe route	Page 23	- Qr for installation assistant
	- Inspection	Page 23	Notice plate
Page 7	Bs en 15287-1	Page 23	Schiedel Installer Rewards
	- Acceptable alternative		
	- Methods of connection		
Page 8-12	Installation instructions		
	- Jointing system		
	- Standard connection flue pipe sections		
	- Individual components		
Page 13-17	Chimney lining components		
Page 18	Offset dimensions		

Approvals



Prima Plus is CE Certified for the following applications:-
 Connecting Flue Pipe - EN1856-2 TÜV 0036 CPR 9195 017
 Chimney Liner - EN1856-2 TÜV 0036 CPR 9195 019
 System Chimney - EN1856-1 TÜV 0036 CPR 9195 018

CE Designations are as follows:-	High Temperature Applications	Low Temperature Applications
Connecting Flue Pipe	T600 N1 W V2 L50060 G400 M*	T200 P1 W V2 L50060 O200 M* T200 N1 W V2 L50060 O200 M*
Chimney Liner	T600 N1 W V2 L50060 G	T200 P1 W V2 L50060 O
System Chimney	T450 N1 W V2 L50060 G50** T450 N1 D V2 L50060 G50***	T200 P1 W V2 L50060 O200

- * *M stands for measured distance to combustibles on a connecting flue pipe application in the range of diameters Ø150-Ø200
- * For other diameters in the range the following distances should be used:
- * When The product is used on solid fuel applications
- * Ø100 = 375mm Ø130 = 390mm

- ** Used internally inside a non combustible shaft
- *** Insulated and used internally inside a suitable enclosure

The Prima Plus range is manufactured under the strict requirements of BS EN ISO 9001 Quality management scheme. Prima Plus has corrosion certification from Gastec, MPA and TÜV. Prima Plus is listed by HETAS as a product suitable for solid fuel. .

Design Guide

MANDATORY REQUIREMENTS

Connection to an appliance which is not connected to the fuel supply, should be carried out by a competent person. We recommend the use of HETAS approved installers for solid fuel applications. If installation is carried out by a non HETAS registered installer, the installation must be certified by a local Building Control inspector. Connection to an appliance that is connected to the fuel supply must be carried out by a Gas Safe (Gas) or OFTEC (Oil) registered installer.

The design guide must be read in conjunction with the detailed component installation instructions.

For full design and installation details the key referral documents are:

- BS EN 1856-2: Connecting Flue Pipes and Chimney Liners
- BS EN 1859: Metal Chimneys - Testing Methods
- BS EN 1443: Chimneys - General Requirements
- BS EN 15287-1: Chimneys. Design, installation and commissioning of chimneys. Chimneys for non-room sealed heating appliances.

- Approved Document J: - Combustion appliances and fuel storage systems (England & Wales)
- DFP Technical Booklet L: - Combustion appliances and fuel storage systems (NI)
- Technical Handbook (Domestic & Non Domestic), Section 3 - Environment (Scotland)
- Appliance Installation Instructions and related standards. Other standards covering specific applications will also be relevant and must be adhered to.

Planning permission for a System Chimney may be required, and reference should be made to the local Building Control Department.

Ensure all chimney components are available and check them to ensure there has been no damage. Do not use damaged components.

Prior to Installation

APPLICATIONS

Prima Plus is designed for use on solid fuel, gas and oil burning appliances with continuous operating temperatures of up to 600°C. With the addition of a lip seal gasket to the joint, Prima Plus may be adapted for use on condensing gas and oil appliances with positive pressure of up to 200Pa and continuous operating temperatures of up to 200°C. For condensing applications it is important that any horizontal runs must have a fall of 5°, where headroom makes 5° impossible the minimum acceptable for warranty purposes is 3°. The design must include drainage component must be installed within the system to facilitate the safe removal of condensates.

VENTILATION

It is very important that sufficient air for combustion is provided to the room containing the appliance, to enable correct and efficient working of the system. Reference should be made to the appliance manufacturer's instructions and recommendations are also given in the Building Regulations Document J.

CARBON MONOXIDE ALARMS

The carbon monoxide alarms should comply with BS EN 50291:2001.

Where a new or replacement fixed solid fuel appliance is installed in a dwelling, a carbon monoxide alarm must be provided in the room where the appliance is located.

Please follow manufacturer's instructions with regard to siting and fixing or alternatively:-

- a) On the ceiling at least 300mm from any wall or if it is located on a wall, as high up as possible (above any doors and windows), but not within 150mm of the ceiling and
- b) between 1m and 3m horizontally from the appliance.

N.B Provision of a carbon monoxide alarm should not be regarded as a substitute for correct installation and regular servicing.

HANDLING

It is advised that suitable PPE should be used when handling the products.

Delivery to Site and Storage

Components should be carefully transported and off loaded. They should be inspected to ensure they have not been damaged, and should be stored off the ground and under cover so that they are protected from accidental damage and the adverse effects of weather. Particular care and attention should be taken to avoid surface damage to product with the high temperature painted finish.

Connecting Flue Pipe

APPLIANCE/CHIMNEY CONNECTION

On solid fuel, wood burning or biomass applications requiring a T600 rating, when a single wall connecting flue pipe is used to connect an appliance to a Twin Wall Insulated System Chimney, the lower end of the insulated chimney section must extend a minimum of 425mm below the ceiling. When connecting the appliance to the connecting flue pipe, the joint between the the connecting flue pipe and the appliance outlet must be securely caulked and sealed with non asbestos rope (or suitable alternative) and fire cement.

On gas and oil appliances, where a T200 rating is required what should the distance be below the ceiling?

On gas and oil appliances, where a P rating is required for the flue pipe, then the relevant approved silicone or viton seal should be used to ensure a gas tight joint.

CONNECTING FLUE PIPE DIAMETER

Connecting Flue Pipe Diameter size should be as recommended by the appliance manufacturer. Where there is a requirement for a flue diameter smaller than the appliance spigot, then the operational requirements of the appliance and the configuration of the flue must satisfy the flue sizing requirements of EN13384-1.

DISTANCE TO COMBUSTIBLES

In accordance with building regulations, it is essential that the correct distance to combustible material is maintained. On

solid fuel applications, where there is a risk of soot fire, refer to CE Approvals on page 2 for full details. as per the measured distance M shown on page 2 for Ø150 - Ø200 or 3 x Ø.

Connecting Flue Pipe

CONNECTING FLUE PIPE ROUTE

Single wall connecting flue pipes should only be used to connect appliances to a Chimney. They should not pass through any roof space, partition, internal wall or floor, except to pass directly into a chimney through a wall of the chimney.

Connecting flue pipes should be located as to avoid igniting combustible material.

On solid fuel appliances the maximum length of a connecting flue pipe is 2m. This distance is reduced to 1.5m if any of the acceptable alternative methods of connection are adopted as per BS EN15287-1. (See p.5 for full details.)

When a single wall connecting flue pipe is used to connect an appliance to a Twin Wall Insulated System Chimney, the lower end of the insulated chimney section must extend a minimum of 425mm below the ceiling.

On appliances with a top outlet, it is recommended that a vertical run of at least 600mm should be allowed immediately above the appliance prior to any change of direction.

On appliances with a rear outlet, it is recommended that there is maximum of 150mm in the horizontal run however under certain conditions, as described in alternative methods in BS EN 15287-1, this may be increased to 450mm. (See p.5-6 for full details.)

Within a system (Chimney + Connecting Flue Pipe) there should be no more than 4 changes of direction of maximum 45°. 90° Factory made bends or tees within the system may be treated as being equal to two 45° bends (as per Document J of the Building Regulations issued October 2010).

INSPECTION

Provision should be made for inspecting and cleaning the chimney system. This is important on solid fuel applications.

An inspection pipe, inspection elbow or a 90° or 135° Tee with tee cap can form a suitable inspection point (unless cleaning/inspection can be done through the appliance). To aid cleaning, sufficient distance should be left between changes of direction to permit the safe passage of cleaning brushes within the system. It is recommended that chimneys serving solid fuel appliances be swept as frequently as necessary, but at least twice a year.

BS EN 15287-1

Acceptable alternative Methods of connection

Where a horizontal connecting flue of more than 150mm is required to connect a solid fuel fired appliance to a chimney, an installation method as per the examples below may be used provided the following criteria is met:-

- The maximum length of horizontal connecting flue pipe does not exceed 450mm;
- A Defra exempt appliance or an appliance, which is limited to burning authorised smokeless fuel only, is installed;
- A calculation according to BS EN13384-1 has indicated safe operation of the proposed configuration, and the results of the calculation are left with the householder along with the appliance installation instructions;
- The appliance manufacturer agrees in writing to the proposed configuration;
- The chimney manufacturer agrees in writing to the proposed configuration;
- The total length of single wall connecting flue pipe is not more than 1.5m;
- The appropriate distances to combustible materials from both the appliance and the connecting flue pipe are maintained.

Top Outlet Single Wall Connecting Flue Pipe into Re-lined Masonry Chimney

Top Outlet Single Wall Connecting Flue Pipe through Solid Wall into Twin Wall System Chimney

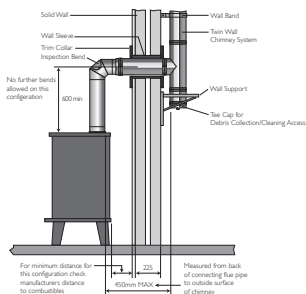
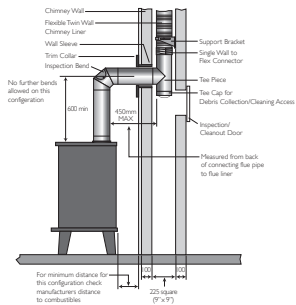

Rear Outlet Single Wall Connecting Flue Pipe into Re-lined Masonry Chimney

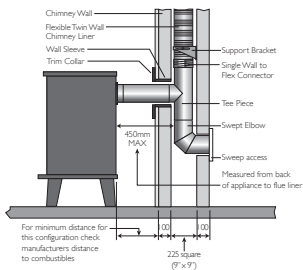

NB Where the connecting flue pipe from the appliance passes through any wall other than the existing chimney wall, the connecting flue pipe must be a System Chimney of twin wall insulated design.

Installation Instructions

JOINT DETAIL

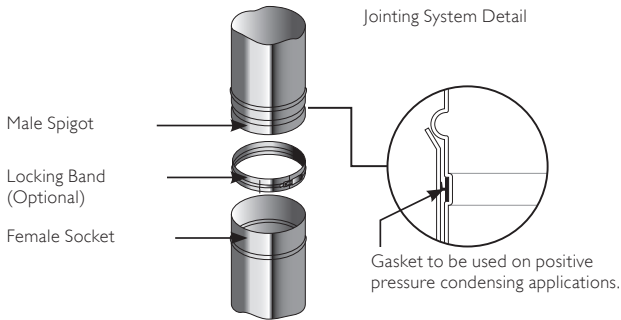

STANDARD SECTIONS (PIPES, TEES AND ELBOWS)

All flue gas bearing components must be installed with the male spigot pointing towards the appliance.

With the exception of the direct connection to the appliance, there is no requirement to apply sealant to the joints of the Prima Plus system.

CONNECTING TO AN APPLIANCE

The male spigot is pushed inside the appliance outlet. The joint should then be sealed to suit each application.

APPLIANCE CONNECTOR - NON CONDENSING GAS /OIL /SOLID FUEL

The joint between the connecting flue pipe and the appliance should be securely caulked and sealed using non asbestos fibre rope (or alternative) and fire cement.

CONDENSING/IMPERIAL APPLIANCE CONNECTOR

The joint between the Appliance connector and the appliance outlet should be sealed with silicone sealant (or alternative) when used on condensing appliances.

Installation Instructions

LOCKING BAND

A locking band is required on every joint between components. Locking bands need to be ordered separately

PRIMA PLUS

Prima Plus is converted for use on positive pressure condensing systems systems by adding a lip seal gasket into the inward bead on the male spigot of the standard components, which are approved as being suitable for use in condensing applications with a P1 designation. (components, which are not specified as dry only).

When installing Prima Plus components, gaskets should be fitted dry and lubricant applied to the internal of the female socket of the standard components (see Fig.1)

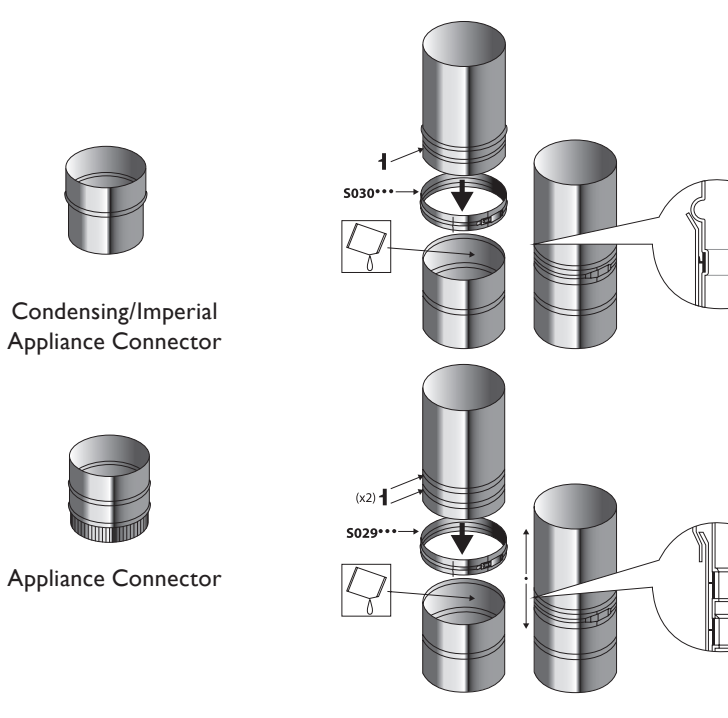

Installation Instructions

ADAPTOR PRIMA PLUS TO ICID PLUS

This component is used to convert from Prima Plus to the ICID Plus System Chimney. The protruding liner of the adaptor should be pushed down inside the female socket of the connecting flue pipe, with the male collar pointing upwards.



ADAPTOR FROM PRIMA PLUS TO ICS

This component is used to convert from Prima Plus to the ICS System Chimney. The protruding liner of the ICS should be pushed down inside the female socket of the Prima Plus.

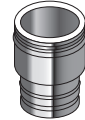

ADAPTOR FROM PRIMA PLUS TO TECNOFLEX PLUS

This component is used to convert from Prima Plus to TecnoFlex Plus. The end of the TecnoFlex Plus should be trimmed to allow the adaptor to be screwed in a clockwise direction onto the TecnoFlex Plus. Care should be taken to ensure that the TecnoFlex Plus liner is fully engaged into the inner sleeve of the adaptor, thereby protecting the cut edges of the TecnoFlex Plus.



INCREASER

This component is used to increase from one diameter to the next diameter (e.g.) 125mm to 150mm. The component is fitted in the same way as a standard pipe length.



VERTICAL / HORIZINATAL DRAIN

Connected to appliance connector to drain condensate from the system. Can also be used in the horizontal at end of header system or inclined run.

ADJUSTABLE PIPE

(Length 500mm with 80mm-400mm adjustment)

The standard adjustable pipe is installed by sliding the male spigot a minimum of 100mm and a max of 400mm into the preceding pipe. The locking band, which is provided with each adjustable pipe is then fastened in place.

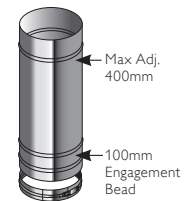

2 PIECE ADJUSTABLE PIPE

The standard adjustable pipe is installed by sliding the male spigot a minimum of 100mm and a max of 400mm into the preceding pipe. The locking band, which is provided with each adjustable pipe is then fastened in place.

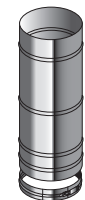

Installation Instructions

90° TEE

This component may be used to connect from a connecting flue pipe to the vertical system chimney at 90° or the branch may be used to locate a draft stabiliser. It is installed as per a standard pipe section.

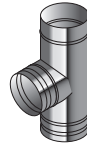

135° TEE - FOR CONDENSING AND NON CONDENSING

This component may be used in combination with a 45° elbow to connect from a connecting flue pipe to the vertical system chimney. It is installed as per a standard pipe section and provides the least resistance to the flow of the flue gases. Please refer to the brochure for codes.



93° TEE

This component must be used in place of a 90° tee to connect from a connecting flue pipe to the vertical system chimney on condensing systems to ensure that condensate can drain down through the system to a drain point. This component is installed as per a standard pipe section.

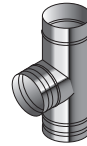

TEE PLUG NON CONDENSING

Used to close off the branch or base of tee. Can also be used to close end of header. Secured with locking band.



TEE PLUG WITH DRAIN

This component is used on condensing systems and provides the facility to collect and drain off condensate from the chimney. It is provided as standard with a 3/4" BSP fitting.



DRAUGHT STABILISER

Used where excessive draught conditions are likely to effect combustion.



SIDE DRAIN CAP

Used where excessive draught conditions are likely to effect combustion.

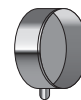

Installation Instructions

INSPECTION PIPE CONDENSING

The inspection length is a component providing the facility for flue inspection and cleaning on condensing or high efficiency appliances with a maximum flue gas temperature of 250°C, and a positive pressure rating of up to 200 Pa. It is installed as per a standard pipe section.



INSPECTION TEE (NON CONDENSING)

The Inspection Tee is a component providing the facility for flue inspection and cleaning. It is installed as per a standard pipe section.

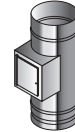

INSPECTION TEE AND LOCKING PLUG

The Inspection Tee and Locking Plug are components together which provides the facility to inspect the flue. The tee is installed as per a standard pipe section. There are two types of Locking Plugs available for either low or high temperature applications. The low temperature plug has a malleable gasket whilst the high temperature plug has a spring seal gasket. Inspection Tee and Locking Plug are sold separately.

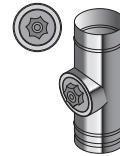

2 PIECE TRIM COLLARS (90° & 45° VARIANTS)

2 piece trim collars are fitted around the Prima Plus pipe where it protrudes through the wall (see Fig. 1). They should be fastened to the wall using an adequate method of fixing.

Fig. 1

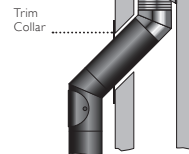

90° Trim Collar							
Ext Ø	130	150	180	200	230	250	300
A mm	134	154	184	204	234	254	304
B mm	280	300	330	350	380	400	450

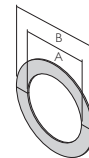

45° Trim Collar							
Ext Ø	130	150	180	200	230	250	300
A mm	134	154	184	204	234	254	304
B mm	94	108	130	144	165	179	214
C mm	280	300	330	350	380	400	450
D mm	192	206	227	242	263	277	312

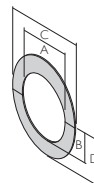

Chimney Lining Components

Note: It is mandatory that when using Prima Plus as chimney liner, the liner **MUST NOT** be supported at the top of the stack. See components below.

LOWERING PIPE

The lowering pipe is used to take the weight of up to 15 x 1m pipe lengths as they are lowered down the existing chimney stack. Rope, which is supplied by the installer, should be fastened to the lowering brackets and the lowering pipe then lowered gently down the chimney stack with the standard pipe lengths being added one at a time up to the maximum load of 15m.

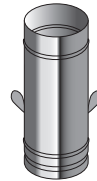

WALL SUPPORT PLATE ADJUSTABLE TOP PLATE

The Support Plate is used as a base support or as an intermediate support to take the weight of up to 15m of Prima Plus, when used as a chimney liner.

It is used in conjunction with cantilever brackets. The spigot below the plate is constructed from adjustable pipe to allow for thermal expansion within the system. The plate is notched at the back to allow the plate to slide into the correct position as required using the full length of the cantilever bracket. The support plate is then attached to the cantilever brackets using the bolts provided through the fixing slots in the top plate.

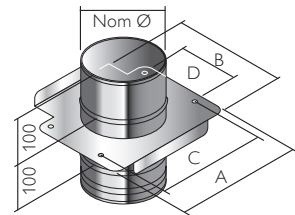

Ext Ø	80	100	130	150	180	200	230	250	300
A mm	176	196	226	246	276	296	326	346	396
B mm	145	165	195	215	245	265	295	315	365
C mm	140	160	190	210	240	260	290	310	360
D mm	60	80	110	130	160	180	210	230	280

Chimney Lining Components

CEILING HANGER

This accessory is designed to support horizontal runs of the chimney from the roof or ceiling and offers adjustment from 130mm to 1115mm. Once the position of the ceiling support has been determined, the section length of uni-rax channel must be securely fixed to the roof or the ceiling using a method of attachment to ensure adequate attachment and support.

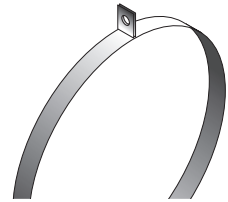

All items are assembled as shown to attach the length of studding to the channel. Attach the stud connector to the length of studding and connect the eye bolt to the connector. Position the split band around the chimney section and secure to the eye bolt using the nut/bolt provided. Maximum support spacing to be no more than 1.5 metres.

SAP Code	190920	190995	110118	110199	110392	112037	112279	112503	112876
Ext Ø	80	100	130	150	180	200	230	250	300
Int Ø	130	153	180	200	230	250	280	300	350

CANTILEVER SUPPORT

Once the position of the support has been established within the chimney stack, secure the cantilever brackets to the wall using expansion bolts to ensure adequate attachment and support.

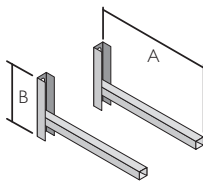

Types 325, 475

Type	325	475	570
Ø Range	125-150	125-200	125-200
A	325	475	570
B	242	242	330

Chimney Lining Components

Cantilever Support Adjustment Dimension Table									
Int Ø	80	100	130	150	180	200	230	250	300
C max									
Type 325	170	140	95	65	-	-	-	-	-
Type 457	320	290	245	215	170	140	95	65	--
Type 570	415	385	340	310	265	235	190	160	85
C min									
Type 325	60	60	60	60	60	60	60	60	60
Type 457	60	60	60	60	60	60	60	60	60
Type 570	60	60	60	60	60	60	60	60	60

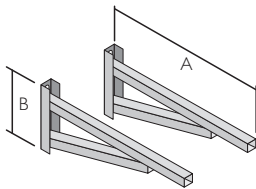

Type 570

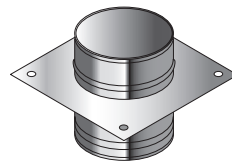

EXPANSION JOINT

The expansion joint must be used at the top of the masonry stack to close off the stack and to allow for thermal expansion within the chimney system. It is provided as a closure plate with a removable adjustable pipe section. The previous pipe section should terminate 200mm below the top of the chimney stack. The top of the masonry stack should be prepared with a layer of cement. Then the adjustable pipe length slides down a minimum of 50mm into the preceding pipe length, with the expansion joint plate bedding down firmly into the cement at the top of the masonry stack. The joint between the plate and the adjustable pipe length should be sealed using an appropriate high temperature sealant. Once securely in place, the plate should be flounced to make weatherproof.

Chimney Lining Components

CONNECTING TERMINALS TO EXPANSION JOINT

The male spigot is pushed down inside the female form of the expansion joint, which incorporates the standard Prima Plus female form. The joint is then secured using a Prima Plus standard locking band, which is purchased separately.

TERMINALS

Raincaps are supplied with a locking band, other terminals are supplied without locking bands. Where a locking band is being used then the terminal should be pushed into place and the adjustment bolt on the locking band clip should be tightened to ensure that the terminal is properly secured to the previous pipe.



Raincap



Open Terminal
with Mesh

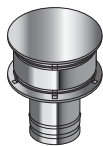

Anti-Splash
Anti-Downdraught
Terminal
(Gastec Approved)



Tapered
Terminal

Chimney Lining Components

ELBOWS 15° - 90° AND ADJUSTABLE INSPECTION

ELBOW

All Elbows provide a change of direction from the vertical. For offset information on standard elbows, please refer to tables on page 13.

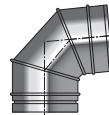

87° FIXED BEND

For use on condensing systems allowing 3° incline.

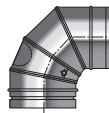

0 - 90° ADJUSTABLE INSPECTION BEND (NON CONDENSING)

The inspection length is a component providing the facility for flue inspection and cleaning.

Offset Dimensions (Made By Assembling 2 Bends)

Offsets 15°									
Int Ø	80	100	130	150	180	200	230	250	300
A	29	29	30	31	32	33	34	34	36
B	218	222	230	236	244	248	256	261	273

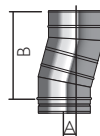

Offsets 30°									
Int Ø	80	100	130	150	180	200	230	250	300
A	60	64	68	70	74	77	81	84	90
B	226	237	252	261	276	287	302	312	336

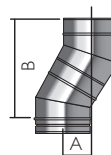

Offsets 45°									
Int Ø	80	100	130	150	180	200	230	250	300
A	110	116	139	139	153	160	168	168	182
B	266	280	335	335	369	386	406	406	440

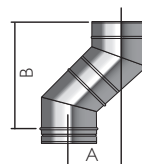

Offset Dimensions

(Made By Assembling 2 Bends and a standard pipe section)

15° Offset with standard Pipe lengths										
	Nom Ømm	80	100	130	150	180	200	230	250	300
Effective Pipe 950	A	275	275	276	277	278	278	280	280	282
	B	1136	1140	1143	1154	1161	1165	1173	1179	1191
Effective Pipe 450	A	145	146	147	148	149	149	150	151	152
	B	653	657	665	671	678	682	690	696	708
Effective Pipe 200	A	80	81	82	83	84	84	85	86	88
	B	411	415	423	429	437	441	449	455	466

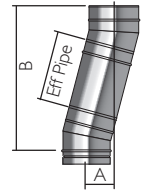

30° Offset with standard Pipe lengths										
	Nom Ømm	80	100	130	150	180	200	230	250	300
Effective Pipe 950	A	536	538	542	545	549	552	556	558	565
	B	1049	1060	1075	1084	1099	1110	1125	1134	1159
Effective Pipe 450	A	286	288	292	295	299	302	306	308	315
	B	616	2627	642	651	666	677	692	701	726
Effective Pipe 200	A	160	164	168	170	174	177	181	184	190
	B	399	410	425	434	449	461	476	485	509

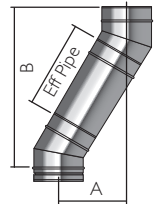

45° Offset with standard Pipe lengths										
	Nom Ømm	80	100	130	150	180	200	230	250	300
Effective Pipe 950	A	782	788	810	810	842	832	840	840	854
	B	938	952	1006	1006	1040	1058	1078	1078	1112
Effective Pipe 450	A	429	434	457	457	471	478	486	486	501
	B	585	598	653	653	687	704	724	724	759
Effective Pipe 200	A	252	257	280	280	294	301	310	310	324
	B	408	421	476	476	510	527	548	548	582

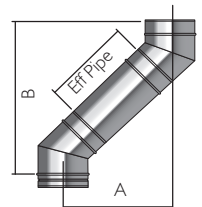

Typical Installation

SYSTEM CHIMNEY ON INDUSTRIAL SPACE HEATER

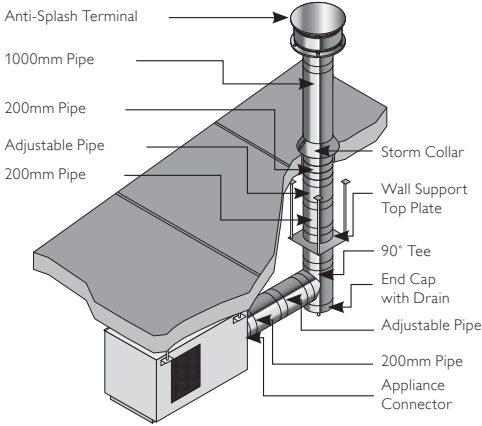

CHIMNEY LINER ON INSET FIRE

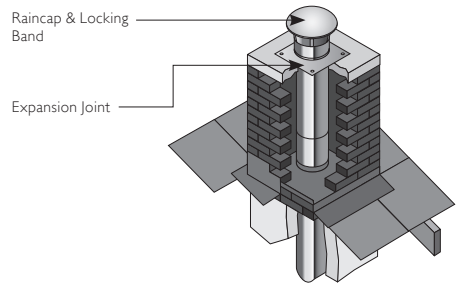

CONNECTING FLUE PIPE ON CONDENSING BOILER

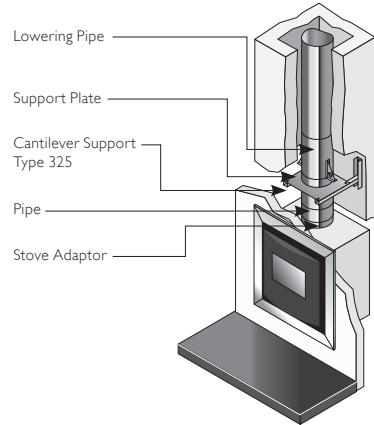
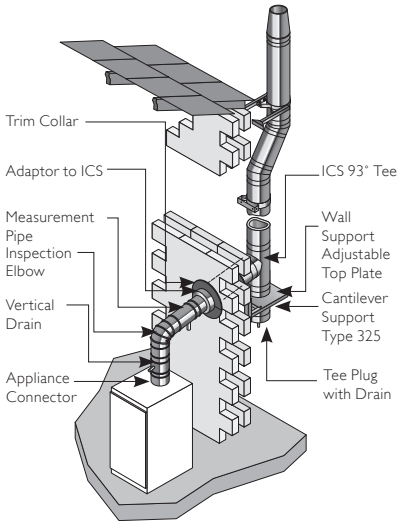

Typical Installation

CONNECTING FLUE PIPE & SYSTEM CHIMNEY ON COMMERCIAL CASCADE SYSTEM WITH CONDENSING APPLIANCES

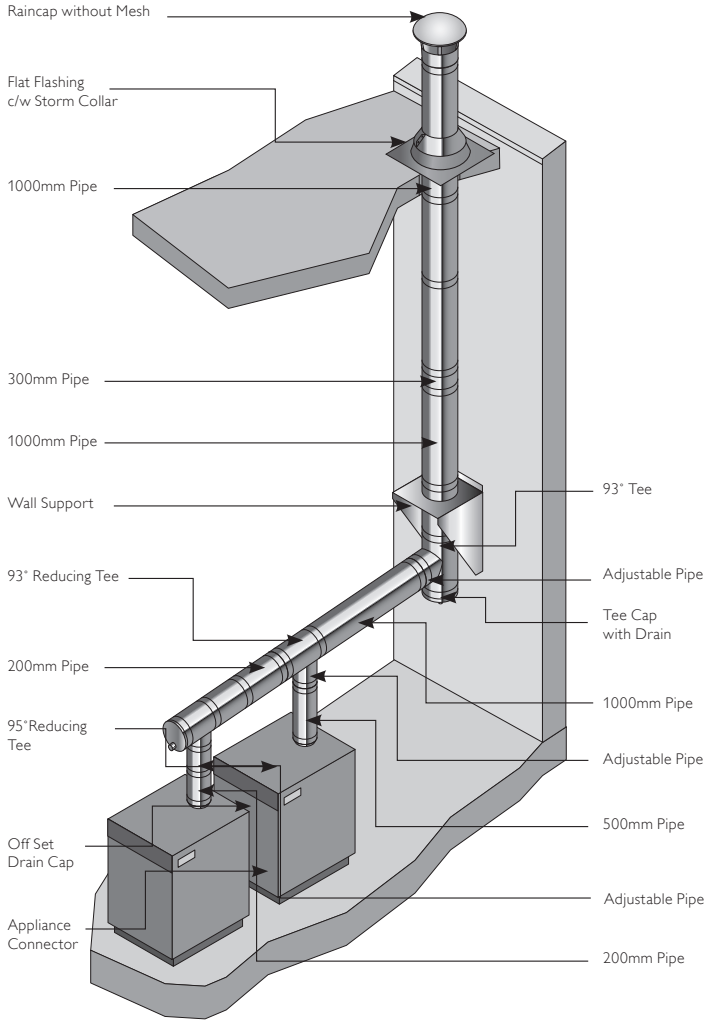

Max Offset Info

(In Same Plane)

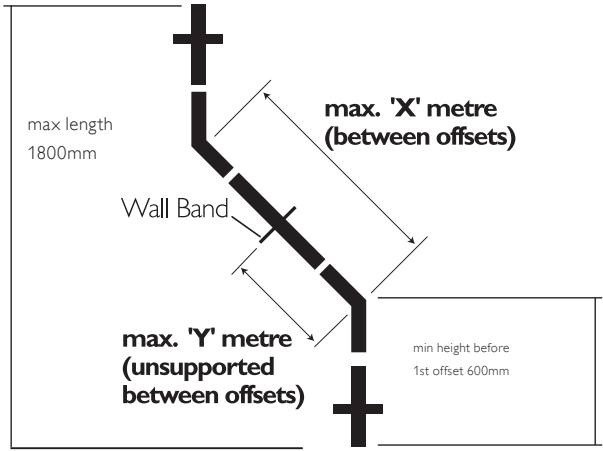

Int Ø	125-200
X (m)	1.5
Y (m)	1

Component Weights

Approximate Weights of Finished Goods(Kg)				
Internal Diameter	Length(mm)	1000	500	250
80		1.22	0.61	0.30
100		1.52	0.76	0.38
130		1.88	0.99	0.49
150		2.28	1.14	0.57
180		2.73	1.37	0.68
200		3.04	1.52	0.76
230		3.49	1.74	0.87
250		3.79	1.9	0.95
300		4.55	2.27	1.14

After Installation

TESTING AND COMMISSIONING PRIOR TO FIRST USE

This is carried out using a flue flow test as described in BS EN 15287 Parts 1 & 2, with reference to the appropriate appliance type.

APPLIANCE OPERATION

If the appliance is slumbered overnight or for longer periods then it is advisable to run the appliance at controlled high fire condition for a period of at least 30 minutes. Prolonged slumbering of the appliance is a contributing factor to a system chimney failure. It is important to maintain sufficiently high flue gas temperatures in order to avoid condensate and acid corrosion problems, and to ensure complete combustion of the fuel.

MULTI-FUEL APPLICATIONS

Multi-Fuel refers to an appliance which may be used to burn either seasoned wood, or approved solid fuels. These fuels should not be mixed, as this increases the risk of deposits being built up in the liner.

MAINTENANCE

Each chimney must be designed to allow for easy inspection; sweeping should be carried out by competent persons. On solid fuel applications a list of HETAS registered sweeps can be found at www.hetas.co.uk. Chimney flue cleaning and inspection require the use of appropriate tooling – under no circumstances should chemical cleaners or mild steel tools be used to sweep stainless steel chimneys. Mechanical sweeping methods such as Rodtech, Rodstation and Gardus, which have been tested and approved by Schiedel Chimney Systems may be used. Cleaning/inspection of any chimney system should be carried out at least once a year, along with maintenance of the appliance, but it is recommended that chimneys serving solid fuel appliances be swept at least twice a year; at the end of the heating season to remove any deposits, which may have built up during the season, and prior to the start of the next heating season to ensure that the flue way is clear of any blockages such as birds nests etc.

We would advise that monthly checks are carried out to ensure that there is no build up of any deposits in the flue way of the connecting flue pipe or system chimney.

FUEL STORAGE AND USAGE

Where solid fuels are being used, correct storage is critical and fuels must be kept dry. Wood must be seasoned prior to use, with a maximum moisture content of 20%. Only approved fuels should be used. Refer to HETAS list for details on www.hetas.co.uk. The fuel used must be suitable for the appliance - please refer to manufacturer's instructions.

Product Guarantee

Under normal operating conditions and providing the system is installed correctly, it should last the lifetime of the appliance, which normally is 10 years. ICS carries a 10 year conditional guarantee. The conditions are that the system is:

- Correctly sized and installed in accordance with the manufacturer's instructions, current Building Regulations and relevant British and European standards.
- Maintained correctly by a qualified and competent person and maintenance records kept updated for both appliance and system chimney.
- Used in combination with an appliance burning only approved fuels in accordance with Schiedel Chimney Systems and the appliance manufacturer's instructions.
- The product registration form must have been filled in by an appropriately qualified installer (see p.3 for details), and returned to Schiedel Chimney Systems Ltd.

For recommended fuels listings, please refer to the HETAS Guide www.hetas.co.uk

In the event of a fault developing in the product due to defective materials or faulty manufacture Schiedel Chimney Systems undertake to replace the product only.

Schiedel Chimney Systems cannot accept liability nor take any responsibility for the installation, building or redecorating costs or any other consequential losses arising.

If any complaint is found to be a result of faulty installation, non-compliance with or abuse contrary to these conditions, the cost of site investigation is chargeable.

Notice Plate

Notice Plate for ICS Product

The Notice plate should be marked up in indelible ink and securely fixed in an unobtrusive but obvious position within the building such as:

- Next to the electricity consumer unit.
- Next to the chimney installation described.
- Next to the water supply stop-cock.

See example alongside:

CE		IMPORTANT SAFETY INFORMATION	
THE CERTIFIED PRODUCT IS A HETAS-CLASSIFIED PRODUCT			
PROPERTY ADDRESS	The Gables, Greenwade, Summerville, NE12 9PP		
THE CURRENT FUEL-BURNING/CLASSIFICATION	Lowvoltage	<input type="checkbox"/> GAS	<input type="checkbox"/> LIQUID
FUEL SUPPLIES FOR	<input checked="" type="checkbox"/> SOLID FUEL	<input type="checkbox"/> GAS	<input type="checkbox"/> LIQUID
APPLIANCE & CHIMNEYING	<input checked="" type="checkbox"/> NEW	<input type="checkbox"/> REPAIR	<input type="checkbox"/> REPAIR
APPLIANCE MODEL NO.	Waldor Martin HTL	WOOD BURNING STOVE	
FUEL TYPE	<input type="checkbox"/> CO	<input checked="" type="checkbox"/> OPEN HEARTH	<input checked="" type="checkbox"/> WOODBURNER PLUS
	<input type="checkbox"/> CO	<input type="checkbox"/> WOODBURNER	<input type="checkbox"/> WOODBURNER
INSTALLATION DATE	01/01/16		
INSTALLER NAME ADDRESS	NEIL BOWEN	<input checked="" type="checkbox"/> HETAS	<input type="checkbox"/> HETAS No. 123456
A.T.N. Other Local Firm Street, Warrington	WARRINGTON		
OTHER INFORMATION	904 Linear fitted. Chimney swept before installation.		
CHEMIST DESIGNATION	T620N1WV27003G	WAVE	CONNECTED FUEL PIPE FIT TO 100
			CHIMNEY LINED WITH CHIMNEY: 800 x 150
GUARANTEE REFERENCE NUMBER	B23C7K1C		
<small>IMPORTANT: Please ensure that this appliance is installed in accordance with the manufacturer's recommendations. It is advised that the space in which the appliance is installed should be in accordance with the relevant Building Regulations. For more information, please refer to the manufacturer's instructions.</small>			

Schiedel Installer Rewards

Exciting news from Schiedel Chimney Systems for Stove and Chimney Installers! Whenever you register an installation with our easy to use, online guarantee registration portal, you will now accrue points based on the number of installations and installation type.

Once you have reached a minimum of 25 points, you can begin to redeem them for £25 Love2Shop vouchers.

So head on over to www.SchiedelRewards.co.uk; register your installations and start earning points!



The Schiedel Installation App

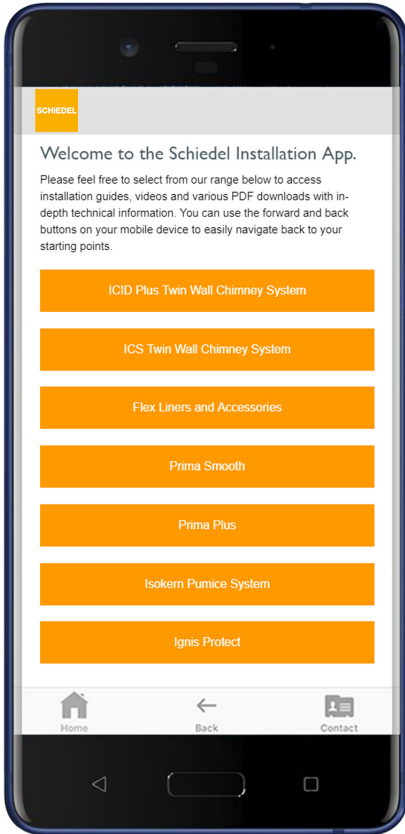

Download the app today, as it offers a number of very useful guides on all aspects of installing an appliance using Schiedel Chimney Systems, including:

- Quick and straightforward reference for installers.
- Video breakdowns of each stage of the installation process, from connection to the appliance through to termination.
- Highlighting the safety critical areas where the chimney penetrates the floors, ceilings, roof and walls.
- Incorporates frequently asked questions information at each stage of the installation process, in line with building regulations.
- An easy-to-use system for downloading full product information and installation instructions.
- Register your Guarantee in the App.

The App is available in the App Store for Apple devices and the Google Play Store for Android devices.

SCHIEDEL

Schiedel Chimney Systems Ltd.

Crowther Estate

Washington

Tyne & Wear NE38 0AQ

Tel. +44 (0)191 416 1150

sales.uk@schiedel.com | www.schiedel.com/uk

A standard
INDUSTRIES COMPANY