



NO LOCKING  
BANDS REQUIRED

## Perimeter Smooth

The aesthetic twin wall system for wood-burning stoves without the need for locking bands.

**SCHIEDEL**

# Product description

## PERMETER SMOOTH PRODUCT FEATURES

Introducing Schiedel PERMETER SMOOTH, the advanced double-wall system that is designed with installers in mind.

The simple push-fit connection means that locking bands are not required, which improves both style and functionality.

The Permeter Smooth range includes all the required accessory components for standard installations both internally and externally.

## PERMETER SMOOTH PRODUCT FEATURES

- Locking bands not required
- Corrosion resistant stainless steel
- Painted black
- Dense, superwool insulation
- Full range of accessories

## Joint design

### EASY TO FIT AND ADDITIONAL SAFETY

Permeter Smooth features a distinctive SuperWool insulation that maintains its properties even under extreme temperatures, reaching up to 1200°C.

Permeter Smooth's thermal expansion capability of up to 18mm ensures that it retains its structural integrity.

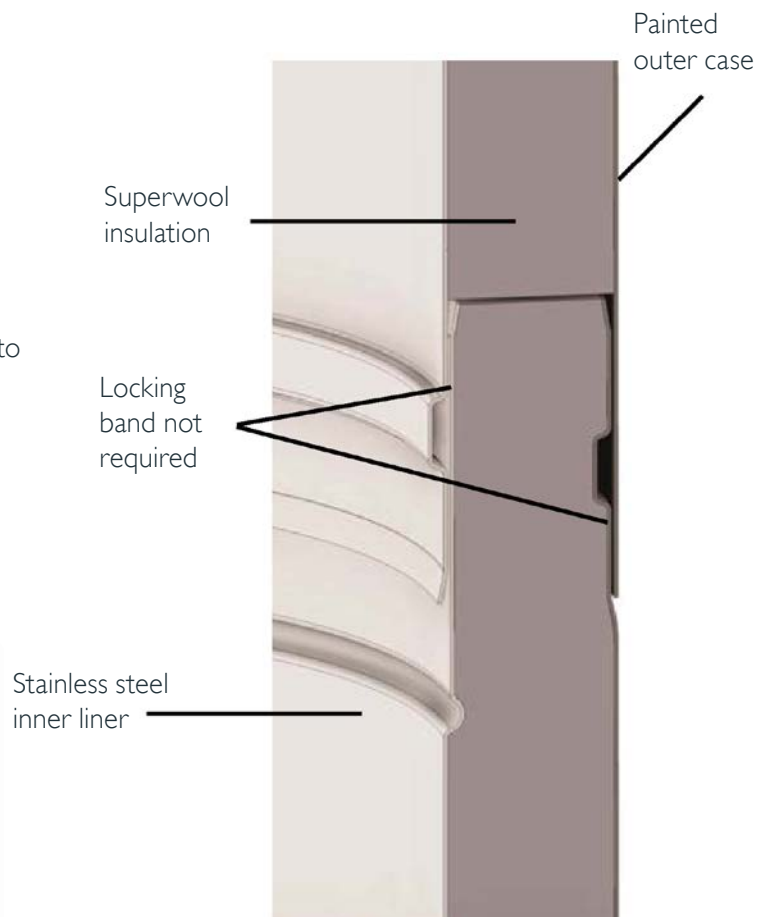
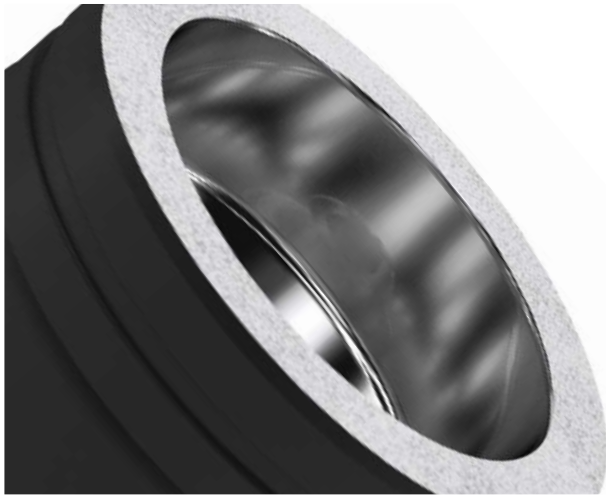

# Technical data

Diameter (internal)	130-200
Diameter (external)	180-250
Liner thickness (internal)	0.5mm
Insulation thickness per diameter	25mm
Weight per diameter (kg/m)	5.8 kg /m - 8.4 kg/m
Outer case thickness	0.6mm
Flue gas temp (dry)	≤ 450 deg C
Liner material:	high grade stainless steel liner 444 : 1.4521
Outer case finish:	Painted black (RAL 9005)
Insulation type:	Superwool blanket
Thermal expansion	18mm
Max. length free standing:	2.0 m above the last support
Max. support spacing (lateral support)	3.0 m
Average thermal resistance (200°C)	0.37m <sup>2</sup> k/W

## CORROSION RESISTANCE

Chimneys are subject to significant corrosion attack by flue gas condensates. Permeter Smooth is specifically designed and manufactured to resist this corrosion.

## CHIMNEY DIAMETER

The chimney size should be as recommended by the appliance manufacturer. Where there is a requirement for a flue diameter smaller than the appliance spigot, then the operational requirements of the appliance and the configuration of the flue must satisfy the flue sizing requirements of EN13384-1 for single appliances.

# Approvals

## SYSTEM CHIMNEY

PERMETER SMOOTH is CE certified to EN 1856-1:2009 with designations:

**T450 N1 D V2 L99050 G60**

System chimney (Ø130-200mm)

## NOTES

**TÜV CE**

# Typical installation

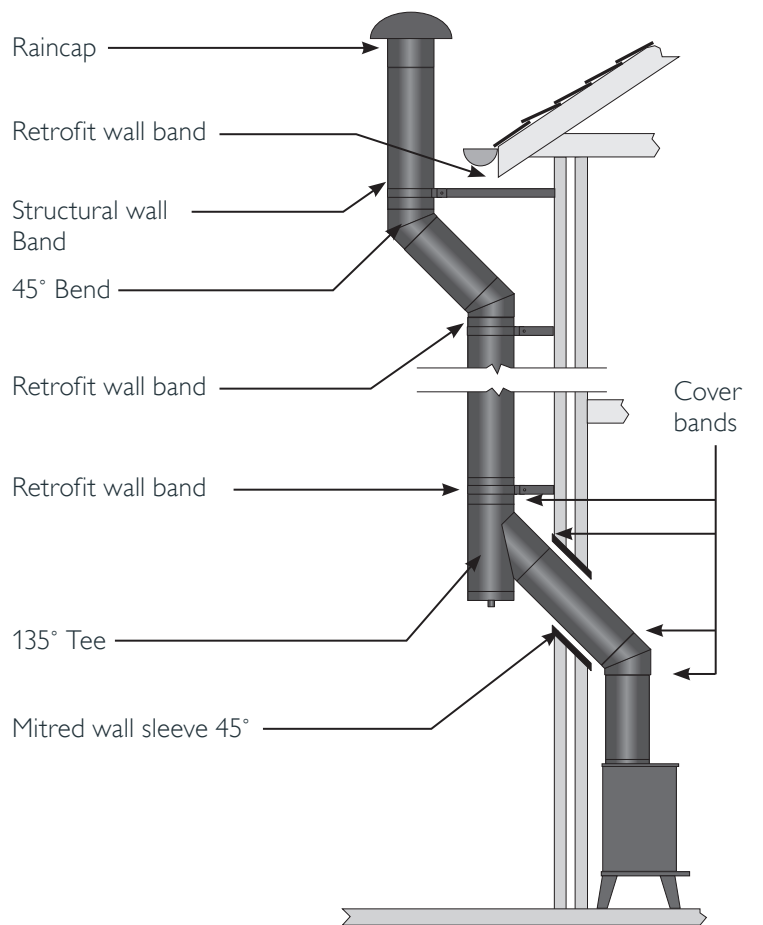
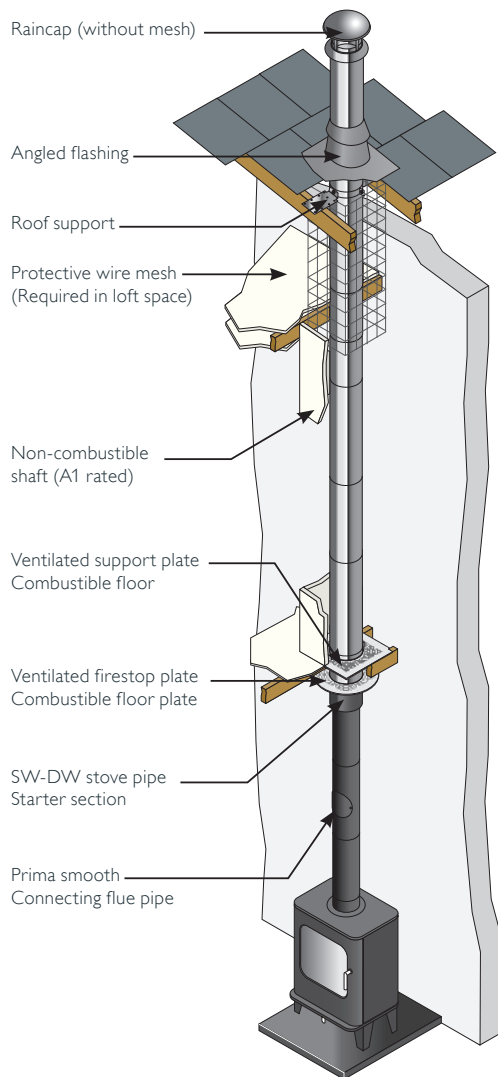

# Starting components

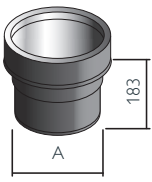

Stove adaptor				
SAP code	177424	177425	177426	177427
Int Ømm	130	150	180	200
Ext Ømm	180	200	230	250
A (mm)	121	146	176	196

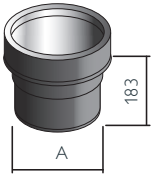

SW-Perimeter Smooth adaptor (short)*				
SAP code	112239	113404	177423	113412
Int Ømm	130	150	180	200
Ext Ømm	180	200	230	250
A (mm)	133	153	182	202

\*Single wall section is designed to sleeve over the preceding pipe and sit on the outside

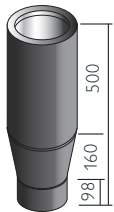

SW-DW Adjustable starter section				
SAP code	177428	177429		
Int Ømm	130	150		
Ext Ømm	180	200		
A (mm)	123	148		

## Pipes

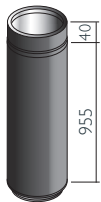

Pipe 1000mm (955mm effective length)				
SAP code	117602	117980	118327	118470
Int Ømm	130	150	180	200
Ext Ømm	180	200	230	250

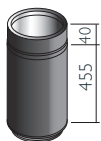

Pipe 500 (455mm effective length)				
SAP code	115398	115924	116359	116722
Int Ømm	130	150	180	200
Ext Ømm	180	200	230	250



Pipe 250mm (205mm effective length)				
SAP code	112610	112889	113356	114258
Int Ømm	130	150	180	200
Ext Ømm	180	200	230	250

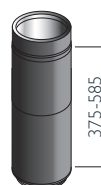

Telescopic Pipe - 2 piece (375-585mm)				
SAP code	157113	157114	157115	157116
Int Ømm	130	150	180	200
Ext Ømm	180	200	230	250

# Pipes

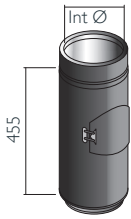

Inspection pipe				
SAP Code	177434	177435	177436	177437
Int Ø (mm)	130	150	180	200
Ext Ø (mm)	180	200	230	250



Cover band				
SAP Code	111115	111297	111631	111877
Int Ø (mm)	130	150	180	200
Ext Ø (mm)	180	200	230	250

# Tees

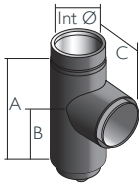

Tee 90 deg				
SAP code	116090	116440	117038	117301
Int Ømm	130	150	180	200
Ext Ømm	180	200	230	250
A (mm)	455	455	455	455
B (mm)	205	205	205	205
C (mm)	130	140	155	165

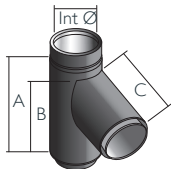

Tee 135 deg				
SAP code	116663	116669	116645	116668
Int Ømm	130	150	180	200
Ext Ømm	180	200	230	250
A (mm)	455	455	455	455
B (mm)	328	329	322	378
C (mm)	328	328	325	376

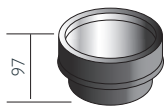

Tee plug				
SAP Code	113062	113082	113108	113105
Int Ø (mm)	130	150	180	200
Ext Ø (mm)	180	200	230	250

# Bends

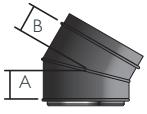

Bend 30 deg				
SAP code	111800	112151	113263	113553
Int Ømm	130	150	180	200
Ext Ømm	180	200	230	250
A (mm)	42	42	52	52
B (mm)	132	132	147	147

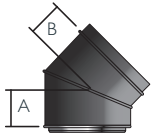

Bend 45 deg				
SAP code	112498	112813	113244	114399
Int Ømm	130	150	180	200
Ext Ømm	180	200	230	250
A (mm)	67	67	77	77
B (mm)	157	157	172	172

# Typical offsets

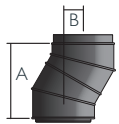

30° offset				
Int Ømm	130	150	180	200
Ext Ømm	180	200	230	250
A (mm)	325	325	371	371
B (mm)	87	87	100	100

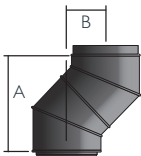

45° offset				
Int Ømm	130	150	180	200
Ext Ømm	180	200	230	250
A (mm)	408	408	399	399
B (mm)	169	169	165	165

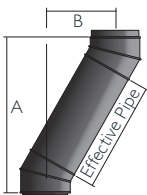

30° offset with standard pipe length					
Int Ømm		130	150	180	200
Ext Ømm		180	200	230	250
955mm effective pipe	A (mm)	1152	1152	1198	1198
	B (mm)	565	565	577	577
455mm effective pipe	A (mm)	719	719	765	765
	B (mm)	315	315	327	327
205mm effective pipe	A (mm)	502	502	549	549
	B (mm)	190	190	202	202

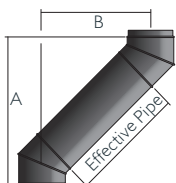

45° offset with standard pipe length					
Int Ømm		130	150	180	200
Ext Ømm		180	200	230	250
955mm effective pipe	A (mm)	1083	1083	1075	1075
	B (mm)	844	844	841	841
455mm effective pipe	A (mm)	730	730	721	721
	B (mm)	491	491	487	487
205mm effective pipe	A (mm)	553	553	544	544
	B (mm)	314	314	310	310

# Firestop components

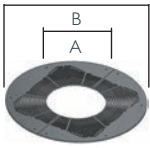

## Combustible floor - G60 round ventilated firestop plate - 2 piece

SAP code	177330	177331	177332	177333
Int Ømm	130	150	180	200
Ext Ømm	180	200	230	250
A (mm)	182	203	233	252
B (mm)	430	450	480	500

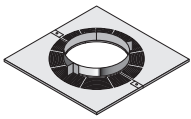

## Combustible floor - G60 rectangular ventilated support plate - 2 piece

SAP code	177704	177705	177706	177707
Int Ømm	130	150	180	200
Ext Ømm	180	200	230	250

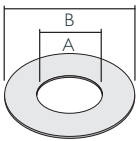

## Bungalow - G60 round solid firestop plate - 1 piece

SAP code	177334	177335
Int Ømm	130	150
Ext Ømm	180	200
A (mm)	182	203
B (mm)	380	400



# Support components



## Retrofit wall support

SAP code	177314	177315	177316	177317
Int Ømm	130	150	180	200
Ext Ømm	180	200	230	250
Adjustment range	185-385	175-375	160-360	150-350

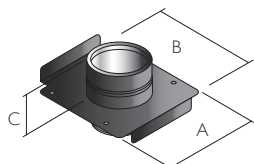

## Top plate

SAP code	114888	114866	114859	114860
Int Ømm	130	150	180	200
Ext Ømm	180	200	230	250
A (mm)	238	258	278	285
B (mm)	305	325	355	353
C (mm)	95	95	95	95

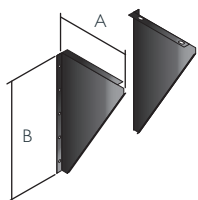

## Side plates (pair)

SAP code	115369	115774	115977	116178
Int Ømm	130	150	180	200
Ext Ømm	180	200	230	250
A (mm)	310	315	345	365
B (mm)	470	470	470	470

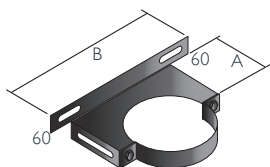

## Retrofit wall band

SAP code	177345	177346	177312	177313
Int Ømm	130	150	180	200
Ext Ømm	180	200	230	250
A (mm)	151	161	176	186
B (mm)	330	350	380	400

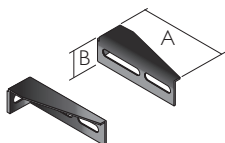

## Retrofit wall band extensions

Type	W1
Adj.	130
A (mm)	130
B (mm)	36
SAP code	130824

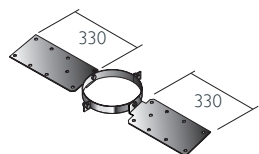

## Roof support (unpainted)

SAP code	100962	100963	100964	100965
Int Ømm	130	150	180	200
Ext Ømm	180	200	230	250

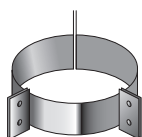

## Guy wire bracket

SAP code	177339	137025	177340	177341
Int Ømm	130	150	180	200
Ext Ømm	180	200	230	250

# Support components

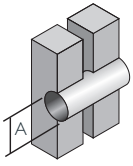

Wall sleeve masonry - 90 deg				
SAP code	126642	127206	177340	177341
Int Ømm	130	150	180	200
Ext Ømm	180	200	230	250
A (mm)	230	250	280	300

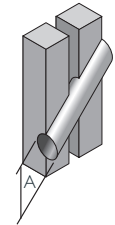

Wall sleeve masonry - 45 deg				
SAP code	126641	127205	127759	128200
Int Ømm	130	150	180	200
Ext Ømm	180	200	230	250
A (mm)	230	250	280	300

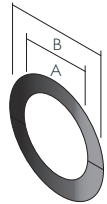

2-piece trim collar 90 deg				
SAP code	177318	177319	177342	177320
Int Ømm	130	150	180	200
Ext Ømm	180	200	230	250
A (mm)	184	204	234	254
B (mm)	330	350	380	400

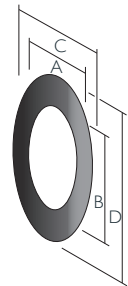

2-piece trim collar 45 deg				
SAP code	177321	177322	177343	177323
Int Ømm	130	150	180	200
Ext Ømm	180	200	230	250
A (mm)	184	204	234	254
B (mm)	130	144	165	179
C (mm)	330	350	380	400
D (mm)	227	242	263	277

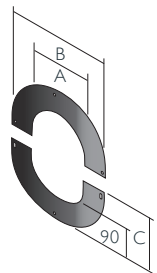

Adjustable Trim Collar 0-20°		
SAP code	177324	177325
Int Ømm	130	150
Ext Ømm	180	200
A (mm)	184	204
B (mm)	364	384
C (mm)	204.5	214.5

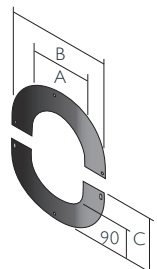

Adjustable Trim Collar 20-35°		
SAP code	177326	177327
Int Ømm	130	150
Ext Ømm	180	200
A (mm)	184	204
B (mm)	364	384
C (mm)	225	241

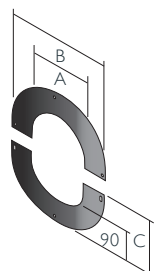

Adjustable Trim Collar 35-45°		
SAP code	177328	177329
Int Ømm	130	150
Ext Ømm	180	200
A (mm)	184	204
B (mm)	364	384
C (mm)	249.5	262

# Flashings

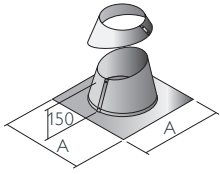

Angled Flashing Kit 5-45°				
SAP code	177336	137026	177337	177338
Int Ømm	130	150	180	200
Ext Ømm	180	200	230	250
A (mm)	700	700	700	700

# Terminals

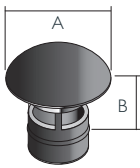

Raincap w/15mm Anti-bird mesh				
SAP code	177430	177431	177432	177433
Int Ømm	130	150	180	200
Ext Ømm	180	200	230	250
A (mm)	90	90	100	100
B (mm)	266	266	362	362

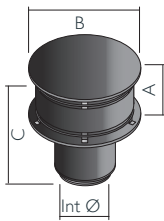

Anti-Splash Terminal (No mesh)				
SAP code	113199	114838	115892	116497
Int Ømm	130	150	180	200
Ext Ømm	180	200	230	250
A (mm)	130	175	200	240
B (mm)	255	300	350	400
C (mm)	175	220	245	285

# System design

## OUTLET SITING

Flue terminations for solid fuel are subject to EN15287-1 2007. Figure A illustrates recommendations for the most commonly encountered outlet terminations. Adjacent taller structures may require increased height. The minimum flue projection through the roof is 600mm to the underside of the terminal.

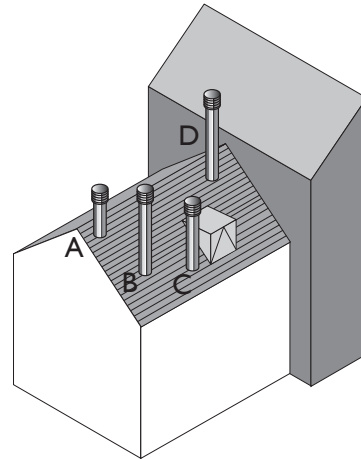

## OUTLET SITING FOR SOLID FUEL APPLIANCES (<50KW)

Point where flue passes through weather surface (Notes 1, 2)		Clearance to flue outlet
A	At or within 600mm of the ridge	At or within 600mm above the ridge
B	Elsewhere on the roof (whether pitched or flat)	At least 2300mm horizontally from the nearest point on the weather surface and: a) at least 1000mm above the highest point of intersection of the chimney and the weather surface; or b) at least as high as the ridge
C	Below (on a pitched roof) or within 2300mm horizontally to an openable roof-light, dormer window or other opening (Note 3)	At least 1000mm above the top of the opening
D	Within 2300mm of an adjoining or adjacent building, whether or not beyond the boundary (Note 3)	At least 600mm above any part of the adjacent building within 2300mm

## TERMINAL TYPES

Rain caps and anti-downdraught terminals are available in two versions, with mesh/spark guard and without mesh. Where a terminal with mesh is used, there is a risk of soot build up, and therefore regular cleaning is required to avoid blockage, particularly when using oil or solid fuel.

Raincaps and Anti-Splash terminals are available. The raincap with mesh, and the Anti-Splash terminal without. Where a Raincap with mesh is used, regular cleaning is required to avoid any blockages as a result of soot build up.

## FLUE ROUTING

The chimney should remain as straight as possible through its vertical run to assist flow. Should it be necessary to offset a chimney run the following guidelines should be adhered to:

It is recommended that a vertical rise of 600mm should be allowed immediately above the appliance before any change of direction.

Within a system, on all fuels, there should be no more than 4 changes of direction of maximum 45°.

90° Factory made bends or tees within the system may be treated as being equal to two 45° bends (see Document J of the Building Regulations issued October 1st 2010).

## PROVISION FOR SWEEPING, CLEANING AND MAINTENANCE

Provision should be made for inspecting and cleaning the chimney. To aid cleaning, sufficient distance should be left between changes of direction to permit the safe passage of cleaning brushes within the system. This is particularly important on solid fuel applications. It is recommended that chimneys serving solid fuel appliances be swept as frequently as necessary but at least twice a year. Choose an access component suitable for your installation unless cleaning/inspection can be done through the appliance.

# Load bearing data

Maximum Load Bearing (metres of pipe)				
Internal Diameter (mm)	130	150	180	200
Retrofit Wall Support	10	10	7	7
Top Plate + Side Plates (A)	15	15	15	15
Top Plate + Side Plates (B)	10	10	10	10
Ventilated Support Plate	12	12	12	9
Retrofit Wall Band	3	3	3	3
Guy Wire Bracket	1.5	1.5	1.5	1.5
Roof Support (above truss)	6	6	6	6
Roof Support (below truss)	4	4	4	4
Extension for Retrofit Wall Band	3	3	3	3

Approximate weights of products (kg)				
Int Ømm	Length			
	1000mm	500mm	250mm	
130	5.84	2.89	1.42	
150	6.58	3.26	1.59	
180	7.69	3.8	1.86	
200	8.43	4.17	2.04	

## Installation

### MANDATORY REQUIREMENTS

We recommend the use of HETAS approved installers for solid fuel applications. For full design and installation details the key referral documents are:

- BS EN 1856-1: Chimneys - System Chimney Products
- BS EN 1859: Metal Chimneys - Testing Methods
- BS EN 1443: Chimneys - General Requirements
- BS EN 15287-1: Chimneys. Design, installation and commissioning of chimneys. Chimneys for non-room sealed heating appliances.
- BS 5440-1: Flueing and ventilation for gas appliances of rated input not exceeding 70kW net (1st, 2nd and 3rd family gases)
- Specification for installation of gas appliances to chimneys and for maintenance of chimneys.
- Approved Document J: - Combustion appliances and fuel storage systems (England & Wales)
- DFP Technical Booklet L: - Combustion appliances and fuel storage systems (NI)
- Technical Handbook (Domestic & Non Domestic), Section 3 - Environment (Scotland)
- Appliance Installation Instructions and related standards. Other standards covering specific applications will also be relevant and must be adhered to.
- Planning permission may be required, and reference should be made to the local Building Control Department.

### ENCLOSURE/SHAFTS

With the exception of the room containing the appliance, where the chimney passes through any part of the building, where there is a risk of accidental human contact, i.e. a bedroom etc., or where there is a risk of contact with combustible materials stored in a cupboard or in the roof-space, the chimney must be enclosed in an appropriate way to meet Building Regulations. This can be achieved by boxing in the chimney in habitable rooms, or by the use of a protective wire mesh frame in roof spaces etc. In all cases the minimum distance to any combustible material, including loft insulation, must be respected according to the table on p.3, and any enclosure should be ventilated using the appropriate ventilated fire stops (see p.8). Enclosure must be constructed using materials consistent with guidance set out in Approved Document B.

### DISTANCE TO COMBUSTIBLES

In accordance with building regulations its is essential that the correct distance to combustible material is maintained. On solid fuel applications, where there is a risk of soot fire, a distance of 60mm to combustibles must be maintained when passing through a combustible floor or enclosed within a shaft.

# Installation

On bungalow applications where the chimney runs through either a combustible or non-combustible ceiling, an unventilated bungalow fire stop plate kit can be used. Please note that an unventilated support plate can not be used above the ceiling in this case. The weight of the chimney should be supported using the roof support. Distance to combustibles must be respected within the ceiling space and mesh frame should be used within the loft space, which must be ventilated.

## JOINTING SYSTEM

All joints in the Perimeter Smooth range are made by means of a simple push-fit jointing method.

There is no requirement for locking/cover bands to be fitted to these joints, but they are available upon request. When offsetting however, Schiedel recommends fitting a Cover-Band to the final joint before the offset, any joint within the offset and the first joint after the offset.

Joints are not permitted within wall and ceiling spaces. Any flue pipe (i.e. single wall) connection to the chimney must be made in the same room as the appliance. The chimney must project at least 425mm below the ceiling. Where a chimney passes through a wall, a wall sleeve must be used to prevent damage to the chimney and the building.

## CONNECTION TO APPLIANCE

Use the appropriate appliance connector, sealing with fire rope and fire cement or high temperature sealant on solid fuel. The length of the inner liner can be trimmed where required.

## APPLIANCE REMOVAL

Use of an adjustable length immediately above the appliance enables removal of the appliance later without dismantling the full system.

## INSPECTION

To conform to Building Regulations, provisions should be made to enable a chimney to be inspected and cleaned. An inspection length or an insulated 90° or 135° Tee can form a suitable inspection point. To aid cleaning, sufficient distance should be left between changes of direction to permit the safe passage of cleaning brushes within the system. This is particularly important on solid fuel applications. It is recommended that chimneys serving solid fuel appliances be swept as frequently as necessary, but at least twice a year.

## CHIMNEY DIAMETER

The chimney size should be as recommended by the appliance manufacturer and must satisfy the flue sizing requirements of EN13384-1 for single appliances.

# Guarantee

## LIFE EXPECTANCY AND GUARANTEE

We are confident in our products and so offer you (the owner) a generous guarantee in relation to the Permeter Smooth system (the System). Provided that you comply with the conditions stated below, the system will be free from defects for 10 years.

The conditions of the guarantee are:

- Correctly sized and installed in accordance with the manufacturer's instructions, current Building Regulations and relevant British and European standards.
- Maintained correctly by a qualified and competent person and maintenance records kept updated for both appliance and chimney/chimney liner.
- Used in combination with an appliance burning only approved fuels in accordance with Schiedel Chimney Systems and the appliance manufacturer's instructions.
- Familiarise yourself with the installation instructions and comply with its provisions in full during the lifetime of your usage of the product (including by keeping the required records safe). Failure to do so will invalidate any guarantee claim.

For more details about the guarantee visit our website. For recommended fuels listings, please refer to the HETAS Guide [www.hetas.co.uk](http://www.hetas.co.uk)

In the event of a fault developing in the product due to defective materials or faulty manufacture Schiedel Chimney Systems undertake to replace the product only. Schiedel Chimney Systems cannot accept liability nor take any responsibility for the installation, building or redecorating costs or any other consequential losses arising. If any complaint is found to be a result of faulty installation, non-compliance with or abuse contrary to these conditions, the cost of site investigation is chargeable.

# Frequently asked questions

## WHAT IS THE MAIN ADVANTAGE OF PERMETER SMOOTH?

The most obvious benefit to Permeter Smooth is the lack of Locking Bands - The system relies on a friction inter-fit between two parts, which provides structure and removes the need for Locking Bands in the majority of the system.

## WHERE WOULD YOU USE COVER BANDS?

Cover Bands are used to provide extra strength to the joint and are 150mm in height. They are also used to achieve an unsupported height of up to 2m above the last support, provided they are installed to the joint directly below the last support and then every subsequent joint.

## ARE THERE OTHER FINISHES AVAILABLE?

We are only launching the black product initially. No plans are currently in place to introduce any additional painted variants, or an unpainted version

## WHAT IS THE WARRANTY/GUARANTEE PERIOD?

The warranty period for Permeter Smooth will be 10 years, with the usual caveats to this guarantee; Installed to our instructions, swept regularly, carried out by a HETAS registered installer/competent person etc.



**SCHIEDEL**

**Schiedel Chimney Systems**  
Crowther Estate, Washington  
Tyne & Wear NE38 0AQ  
Tel. +44 (0)191 416 1150

[sales.uk@schiedel.com](mailto:sales.uk@schiedel.com)  
[schiedel.com/uk](http://schiedel.com/uk)

Follow us on Social Media @SchiedelUK



**A standard**  
INDUSTRIES COMPANY